

Features

- ◆ Operating temperature: -40 to +85℃
- ◆ Efficiency up to 84%
- ◆ 1.5/3.0kVdc isolation
- ◆ Multiple package options
- ◆ International standard pin-out
- ◆ 100% burn-in
- ◆ No external component required
- ◆ UL94V-0 package
- ◆ RoHS/CE compliance
- ◆ With 3 year warranty

General Description

The 2W series dc/dc converters are specially designed for the application of the power supply which is isolated from the input source in the distributed power supply system on the circuit board. Small size, high power density, can save valuable board space.

The chip ceramic capacitors and SMT are used in all series. These converters have characteristics of long life, excellent performance, stability and reliability.

Suitable for occasions where the input power supply is relatively stable, input and output isolated is necessary and the output voltage regulation is not strictly required.

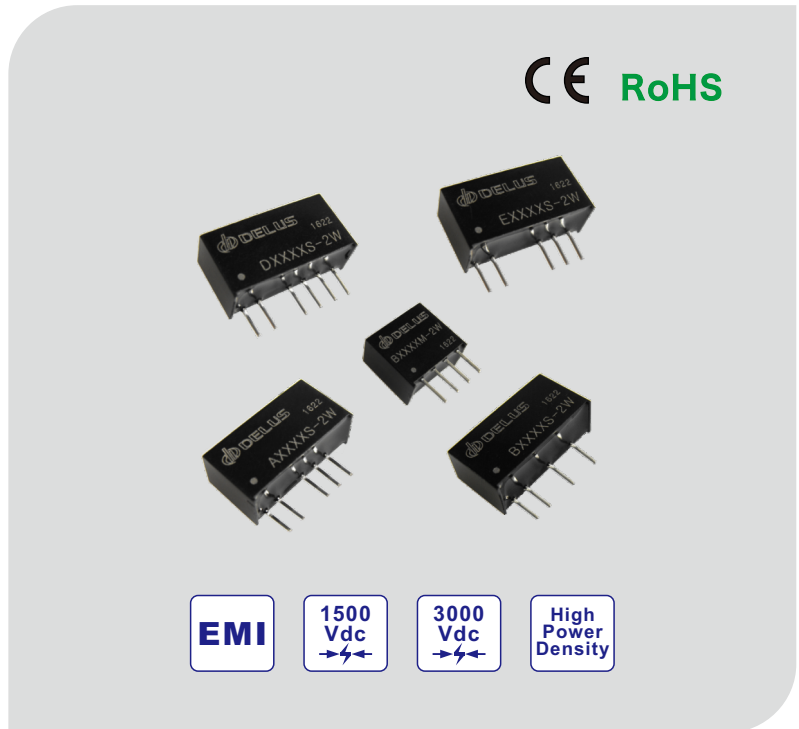

EMC Solution-Recommended Circuit

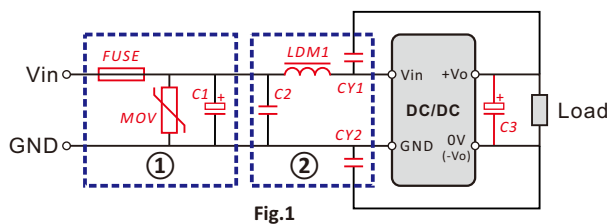

Fig.1

Note: Part ① is the recommended external circuit for EMS test and Part ② for EMI filtering. Choose according to requirements.

Parameter Description			
Vin	3.3V/5V/9V	12V/15V/24V	48V
C2	4.7uF/50V		2.2uF/100V
LDM1	6.8uH		
CY1	-		
CY2	1nF/2kV or 4.5kV		
C3	Choose according fig.3		
If there is no recommended parameters, no external component is required.			

Typical Characteristic Curve

Tolerance Envelope Graph (3.3V)

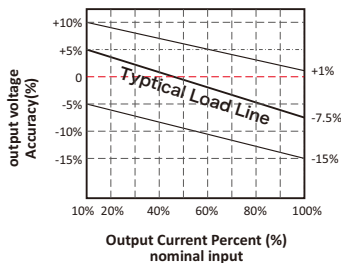

Tolerance Envelope Graph (other)

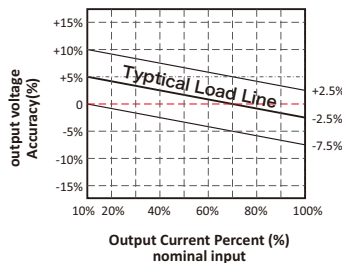

Temperature Derating Curve

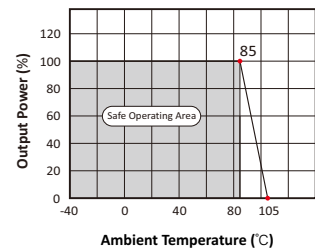

Fig.2

A/B/D/E/F-2W Series

2w, fixed input, isolated & unregulated dual/single output dc-dc converter



Input Specifications					
Item	Test Conditions	Min	Typ	Max	Units
Input Surge Voltage (1 sec max)	3.3V input	-0.7		5	Vdc
	5V input	-0.7		7	
	9V input	-0.7		15	
	12V input	-0.7		15	
	15V input	-0.7		20	
	24V input	-0.7		30	
	48V input	-0.7		60	
Input Filter	"C" filter				
Reverse Polarity Input Current	no support				
Hot Plug	no support				

Output Specifications					
Item	Test Conditions	Min	Typ	Max	Units
Output Power	Ta=-40~+85°C	0.2		2	W
Output Voltage Accuracy	See Tolerance Envelope Graph				
Line Regulation	For vin change of ±1%			1.2	%
Load Regulation	Nominal, 10%-100% load	3.3V output	15	20	
		5V output	12.2	15	
		9V output	8.3	15	
		12V output	7	15	
		15V output	7	15	
24V output	5	15			
Ripple & Noise	DC-20MHz bandwidth		130	300	mVp-p
Temperature Drift	Nominal, 100% load			±0.03	%/°C
Short Circuit Protection				1	s

Isolation Specifications					
Item	Test Conditions	Min	Typ	Max	Units
Isolation Voltage	A/B/D	1500			Vdc
	E/F	3000			
Insulation Resistance	Test at 500Vdc	1000			MΩ
Isolation Capacitance	IN-OUT, 100kHz @ 0.1Vdc		20		pF

Common Specification					
Item	Test Conditions	Min	Typ	Max	Units
Switching Frequency	100% load, input low to high		100		kHz
Operating Temperature		-40		+85	°C
Case Temp Rise	Ta=25°C		45		
Lead Temperature	1.5mm from case for 10 seconds			+300	
Storage Temperature		-50		+130	
Storage Humidity				95	
MTBF	Using MIL-HDBK 217 @ 25°C	1000			k hours
Case Material		Black Plastic (UL94V-0)			

EMC Specification			
EMI	CE	EN55022:2010	Class B (See Fig.1)
	RE	EN55022:2010	Class B (See Fig.1)
EMS	ESD	EN55024:2010/EN61000-4-2	perf. Criterion B
	RS	EN55024:2010/EN61000-4-3	perf. Criterion A

Application Note

1. Requirement on Output Load

To ensure this DC/DC can operate efficiently and reliably, during operation, the minimum output load is not less than 10% of the full load, and that **this product should never be operated under no load!**

When the actual output power is very small, if in the selection phase, it is recommended to select a lower power level model, else please connect a resistor with proper resistance at the output end in parallel to increase the load.

2. Typical Application Circuit

General applications, the circuit according to Fig.3 Typical recommended. The value of each component will be selected according to the following recommended list.

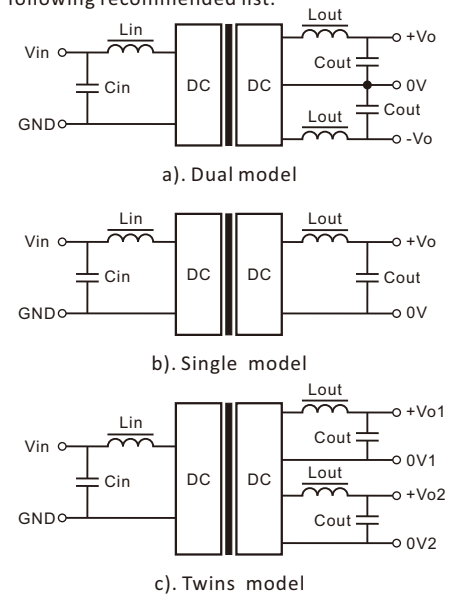

Fig.3

Capacitor and Inductor values Recommended

Cin	Cout	Lin, Lout
10~100uF	3.3V	10uF
	5V	10uF
	9V	4.7uF
	12V	2.2uF
	15V	1uF
	24V	1uF
Dual & Twin models Cout capacitance value halved		

If using a filter inductor, It should be noted "LC" filtering network natural frequency should be staggered with the DC/DC operating frequency to avoid mutual interference.

3. Output regulation, over-current protection

This series of products does not have the voltage regulator function in itself. The easiest way to achieve output voltage regulation, input over-voltage and over-current protection is to connect a linear regulator with these functions to input or output end in series.

A_S-2W Series

2w, fixed input, 1500Vdc isolated & unregulated dual output dc-dc converter



Product Program							
Certificate	Model	Eff (%)	Input		Output		Max Capacitive Load (uF)
			Voltage(Vdc)		Vdc	mA	
			Nominal	Range	Nominal	Max	
CE/RoHS	A0505S-2W	75	5	4.5-5.5	±5	±200	100
	A0509S-2W	82			±9	±111	
	A0512S-2W	83			±12	±83	
	A0515S-2W	85			±15	±67	
	A0524S-2W	85			±24	±42	
CE/RoHS	A0912S-2W	85	9	8.1-9.9	±12	±83	100
	A0915S-2W	86			±15	±67	
CE/RoHS	A1205S-2W	76	12	10.8-13.2	±5	±200	100
	A1209S-2W	83			±9	±111	
	A1212S-2W	85			±12	±83	
	A1215S-2W	87			±15	±67	
	A1224S-2W	85			±24	±42	
CE/RoHS	A1515S-2W	75	15	13.5-16.5	±15	±67	100
CE/RoHS	A2405S-2W	73	24	21.6-26.4	±5	±200	100
	A2409S-2W	82			±9	±111	
	A2412S-2W	85			±12	±83	
	A2415S-2W	85			±15	±67	
	A2424S-2W	85			±24	±42	
CE/RoHS	A4815S-2W	82	48	43.2-52.8	±12	±83	100

Dimensions First Angle Proj

Pin	A_S-2W
1	Vin
2	GND
4	-Vo
5	0V
6	+Vo

Note:
 All size units mm,
 Diameter of all terminal 0.5mm,
 Distance between all adjacent terminal 2.54mm
Isolation: 1500Vdc
Weight: 2.4g

Functional Diagram

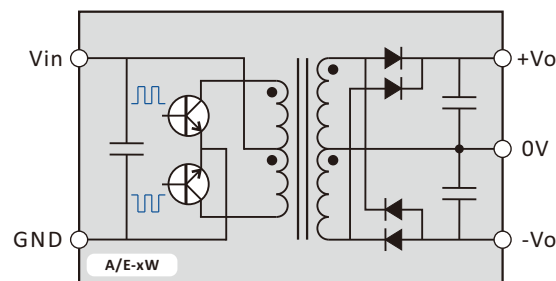

B_S-2W Series

2w, fixed input, 1500Vdc isolated & unregulated single output dc-dc converter



Product Program							
Certificate	Model	Eff (%)	Input		Output		Max Capacitive Load (uF)
			Voltage(Vdc)		Vdc	mA	
			Nominal	Range	Nominal	Max	
CE/RoHS	B0503S-2W	81	5	4.5-5.5	3.3	600	220
	B0505S-2W	83			5	400	
	B0509S-2W	86			9	222	
	B0512S-2W	84			12	167	
	B0515S-2W	85			15	133	
	B0524S-2W	86			24	83	
CE/RoHS	B0905S-2W	86	9	8.1-9.9	5	200	220
	B0924S-2W	86			9	111	
CE/RoHS	B1203S-2W	82	12	10.8-13.2	3.3	600	220
	B1205S-2W	83			5	400	
	B1209S-2W	84			9	222	
	B1212S-2W	84			12	167	
	B1215S-2W	83			15	133	
	B1224S-2W	87			24	83	
CE/RoHS	B1515S-2W	87	15	13.5-16.5	15	133	220
CE/RoHS	B2403S-2W	82	24	21.6-26.4	3.3	600	220
	B2405S-2W	83			5	400	
	B2409S-2W	83			9	222	
	B2412S-2W	84			12	167	
	B2415S-2W	83			15	133	
	B2424S-2W	86			24	83	
CE/RoHS	B4812S-2W	83	48	43.2-52.8	12	167	220

Dimensions First Angle Proj

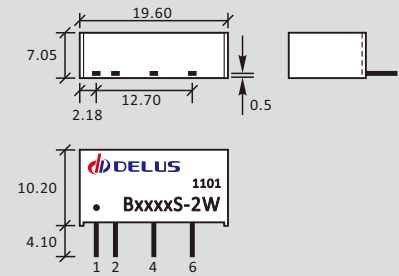

Pin	B_S-2W
1	Vin
2	GND
4	0V
6	+Vo

Note:

All size units **mm**,
 Diameter of all terminal 0.5mm,
 Distance between all adjacent terminal 2.54mm
Isolation: 1500Vdc
Weight: 2.4g

Functional Diagram

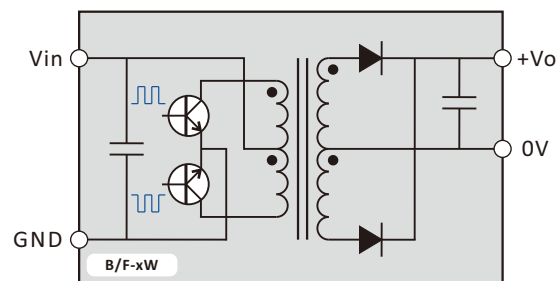

B_M-2W Series

2w, fixed input, 1500Vdc isolated & unregulated single output dc-dc converter



Product Program							
Certificate	Model	Eff (%)	Input		Output		Max Capacitive Load (uF)
			Voltage(Vdc)		Vdc	mA	
			Nominal	Range	Nominal	Max	
CE/RoHS	B0505M-2W	83	5	4.5-5.5	5	400	220
	B0509M-2W	86			9	222	
	B0512M-2W	84			12	167	
	B0515M-2W	85			15	133	
	B0524M-2W	86			24	83	
CE/RoHS	B1205M-2W	83	12	10.8-13.2	5	400	220
	B1209M-2W	84			9	222	
	B1212M-2W	84			12	167	
	B1215M-2W	83			15	133	
	B1224M-2W	87			24	83	
CE/RoHS	B2405M-2W	83	24	21.6-26.4	5	400	220
	B2409M-2W	83			9	222	
	B2412M-2W	84			12	167	
	B2415M-2W	83			15	133	
	B2424M-2W	86			24	83	

Dimensions First Angle Proj

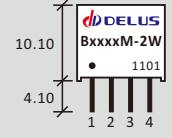
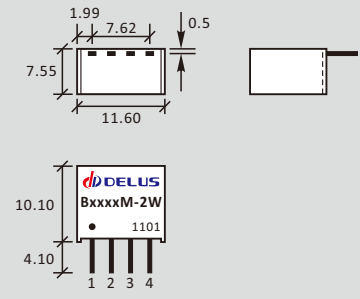

Pin	B_M-2W
1	GND
2	Vin
3	0V
4	+Vo

Note:

All size units **mm**,
 Diameter of all terminal 0.5mm,
 Distance between all adjacent terminal 2.54mm
Isolation: 1500Vdc
Weight: 1.6g

Functional Diagram

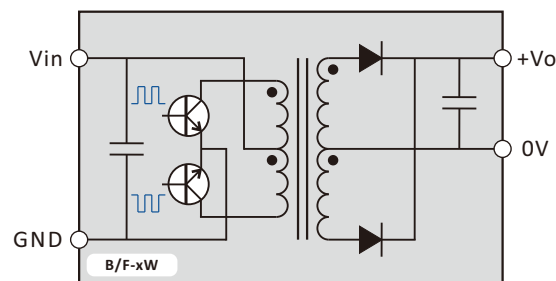

D_S-2W Series

2w, fixed input, 1500Vdc isolated & unregulated twins output dc-dc converter



Product Program							
Certificate	Model	Eff (%)	Input		Output		Max Capacitive Load (uF)
			Voltage(Vdc)		Vdc	mA	
			Nominal	Range	Nominal	Max	
CE/RoHS	D0505S-2W	75	5	4.5-5.5	5/5	200/200	100
	D0509S-2W	82			9/9	111/111	
	D0512S-2W	83			12/12	83/83	
	D0515S-2W	85			15/15	67/67	
CE/RoHS	D1205S-2W	76	12	10.8-13.2	5/5	200/200	100
	D1209S-2W	83			9/9	111/111	
	D1212S-2W	85			12/12	83/83	
	D1215S-2W	87			15/15	67/67	
CE/RoHS	D2405S-2W	74	24	21.6-26.4	5/5	200/200	100
	D2409S-2W	82			9/9	111/111	
	D2412S-2W	85			12/12	83/83	
	D2415S-2W	85			15/15	67/67	
	D2418S-2W	82			18/18	56/56	

Dimensions First Angle Proj

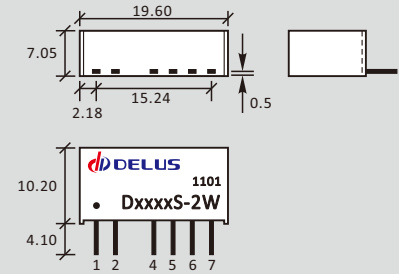

Pin	D_S-2W
1	Vin
2	GND
4	0V2
5	+Vo2
6	0V1
7	+Vo1

Note:

All size units **mm**,
 Diameter of all terminal 0.5mm,
 Distance between all adjacent terminal 2.54mm
Isolation: 1500Vdc
Weight: 2.7g

Functional Diagram

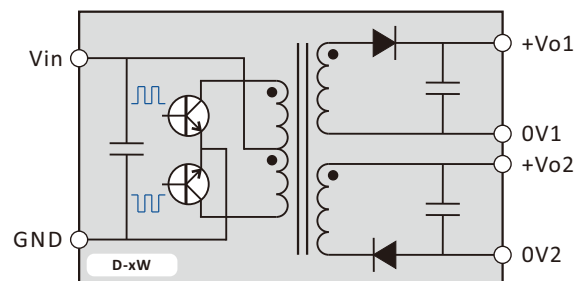

E_S-2W Series

2w, fixed input, 3000Vdc isolated & unregulated dual output dc-dc converter



Product Program							
Certificate	Model	Eff (%)	Input		Output		Max Capacitive Load (uF)
			Voltage(Vdc)		Vdc	mA	
			Nominal	Range	Nominal	Max	
CE/RoHS	E0505S-2W	75	5	4.5-5.5	±5	±200	100
	E0509S-2W	82			±9	±111	
	E0512S-2W	83			±12	±83	
	E0515S-2W	85			±15	±67	
	E0524S-2W	85			±24	±42	
CE/RoHS	E1205S-2W	76	12	10.8-13.2	±5	±200	100
	E1209S-2W	83			±9	±111	
	E1212S-2W	85			±12	±83	
	E1215S-2W	87			±15	±67	
	E1224S-2W	85			±24	±42	
CE/RoHS	E2405S-2W	73	24	21.6-26.4	±5	±200	100
	E2409S-2W	82			±9	±111	
	E2412S-2W	85			±12	±83	
	E2415S-2W	85			±15	±67	
	E2424S-2W	85			±24	±42	

Dimensions First Angle Proj

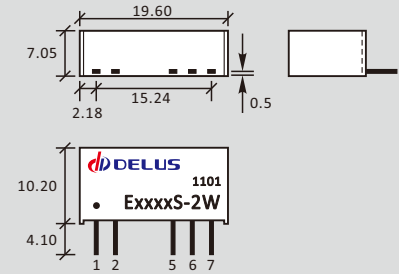

Pin	E_S-2W
1	Vin
2	GND
5	-Vo
6	0V
7	+Vo

Note:

All size units **mm**,
 Diameter of all terminal 0.5mm,
 Distance between all adjacent terminal 2.54mm
Isolation: 3000Vdc
Weight: 2.4g

Functional Diagram

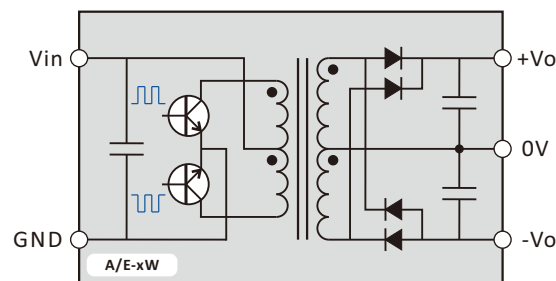

F_S-2W Series

2w, fixed input, 3000Vdc isolated & unregulated single output dc-dc converter



Product Program							
Certificate	Model	Eff (%)	Input		Output		Max Capacitive Load (uF)
			Voltage(Vdc)		Vdc	mA	
			Nominal	Range	Nominal	Max	
CE/RoHS	F0503S-2W	81	5	4.5-5.5	3.3	600	220
	F0505S-2W	83			5	400	
	F0509S-2W	86			9	222	
	F0512S-2W	84			12	167	
	F0515S-2W	85			15	133	
	F0524S-2W	86			24	83	
CE/RoHS	F1203S-2W	82	12	10.8-13.2	3.3	600	220
	F1205S-2W	83			5	400	
	F1209S-2W	84			9	222	
	F1212S-2W	84			12	167	
	F1215S-2W	83			15	133	
	F1224S-2W	87			24	83	
CE/RoHS	F2403S-2W	82	24	21.6-26.4	3.3	600	220
	F2405S-2W	83			5	400	
	F2409S-2W	83			9	222	
	F2412S-2W	84			12	167	
	F2415S-2W	83			15	133	
	F2424S-2W	86			24	83	

Dimensions First Angle Proj

Pin	F_S-2W
1	Vin
2	GND
5	0V
7	+Vo

Note:
 All size units mm,
 Diameter of all terminal 0.5mm,
 Distance between all adjacent terminal 2.54mm
Isolation: 3000Vdc
Weight: 2.4g

Functional Diagram

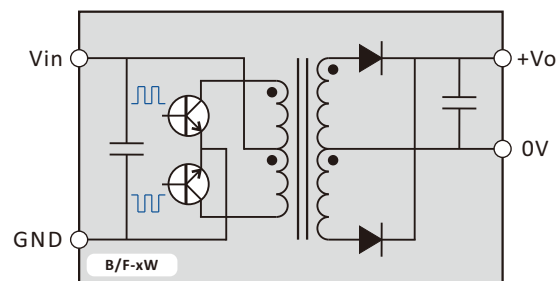

F_M-2W Series

2w, fixed input, 3000Vdc isolated & unregulated single output dc-dc converter



Product Program							
Certificate	Model	Eff (%)	Input		Output		Max Capacitive Load (uF)
			Voltage(Vdc)		Vdc	mA	
			Nominal	Range	Nominal	Max	
CE/RoHS	F0505M-2W	83	5	4.5-5.5	5	400	220
	F0509M-2W	86			9	222	
	F0512M-2W	84			12	167	
	F0515M-2W	85			15	133	
	F0524M-2W	86			24	83	
CE/RoHS	F1205M-2W	83	12	10.8-13.2	5	400	220
	F1209M-2W	84			9	222	
	F1212M-2W	84			12	167	
	F1215M-2W	83			15	133	
	F1224M-2W	87			24	83	
CE/RoHS	F2405M-2W	83	24	21.6-26.4	5	400	220
	F2409M-2W	83			9	222	
	F2412M-2W	84			12	167	
	F2415M-2W	83			15	133	
	F2424M-2W	86			24	83	

Dimensions First Angle Proj

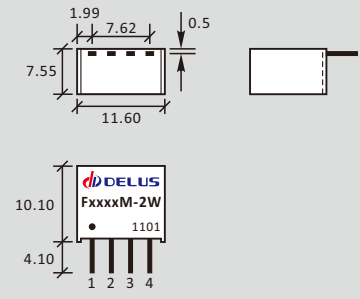

Pin	F_M-2W
1	GND
2	Vin
3	0V
4	+Vo

Note:

All size units **mm**,
 Diameter of all terminal 0.5mm,
 Distance between all adjacent terminal 2.54mm
Isolation: 3000Vdc
Weight: 1.6g

Functional Diagram

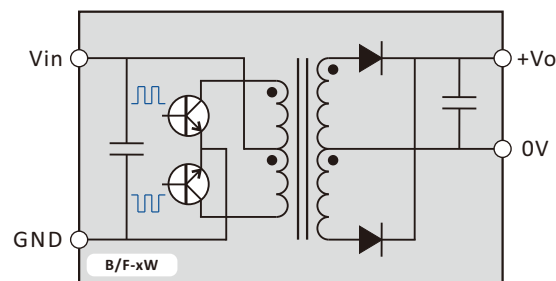

File Release Notes

DBN-102 Technical Data Sheet Version



No.	Version	Date	Description
1	V0	2011/11/01	First release
2	A/0	2016/07/01	Change document version definition
3			
4			
5			

1. All data in addition to particular things, are Ta = 25°C, humidity<75%, nominal input voltage and output measured at rated load;
2. Non-standard models with some of the following indicators may be different from the specific circumstances of the Secretary to direct contact with me;
3. In the use of this manual, if some of them do not quite understand terms please refer to our <<DC/DC Converter Application Guide>>;
4. The Company focused on technological improvements, product specifications and parameter updates without notice, to pay attention to the latest information on website.

All Delus Corporation's products are manufactured, assembled and tested utilizing ISO9001 quality systems.
For information regarding Delus Corporation and its products please see website: www.delus-power.com

Delus Guangzhou Electronic Technology CO.,LTD

Tel: +86-20-32206616 Fax: +86-20-32206658 Mail: service@delus.cn